

TO BE USED IN

GT-N30/SL

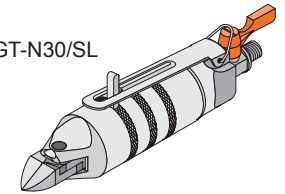

GT-NR30

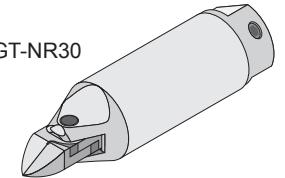

GT-NS30

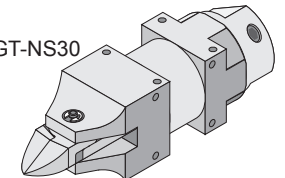

GT-NB30LW-10TM
GT-NB30LW-10SM

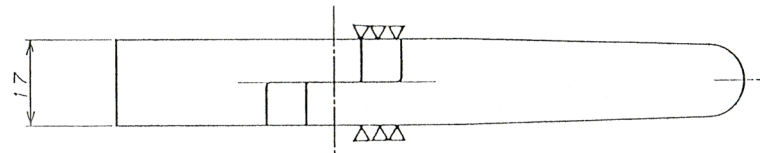
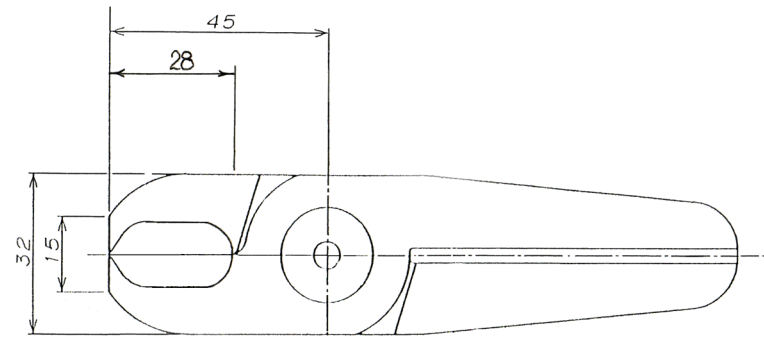
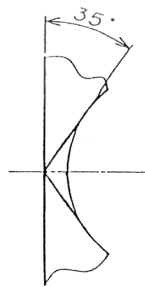
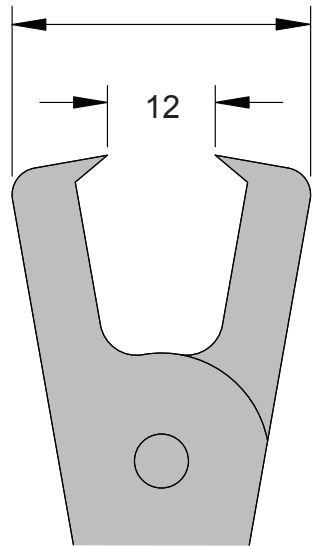
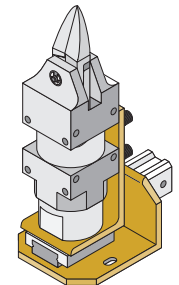

| | | | | | |
|-------------------|------------|--|--|--------------------|-------------|
| ALTERNATE BLADES | | Rev. | | Rev. Date: 5.18.09 | |
| CARBIDE: | N30AEB1272 |  NIPPER BLADE | | APPLICATION: | PLASTIC |
| HIGH SPEED STEEL: | N30AEH1461 | | | MATERIAL: | ALLOY STEEL |
| | | | | EDP #: | 360166 |
| | | ALT P/N: | | DRAWING #: | |

The **VESSEL** North American Distributor



JDV Products Inc.

22-01 Raphael St., Fair Lawn, NJ 07410
Tel: 201-796-1720 Fax: 201-796-9399
www.vesseltools.com



Certified Woman Owned Small Business