

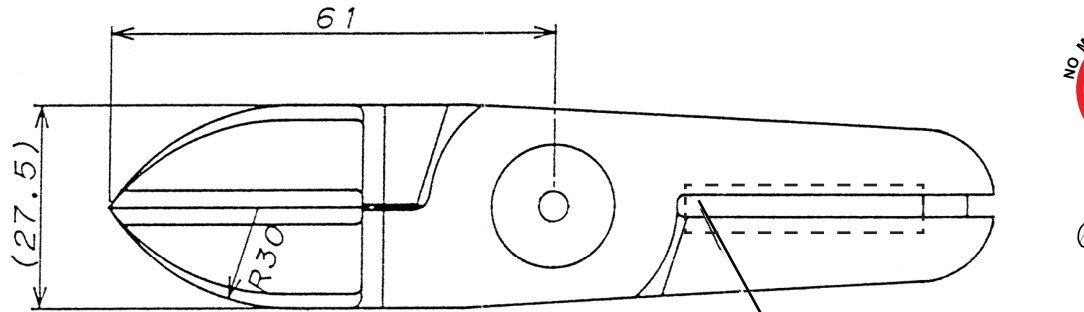

CAUTION
Use Appropriate
Safety Precautions

Strong Magnetic Field

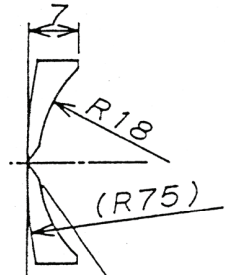
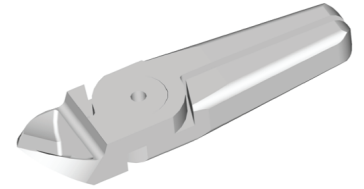

POWERFUL NEODYMIUM MAGNET

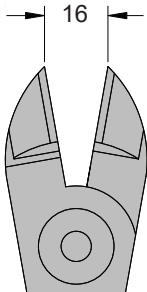
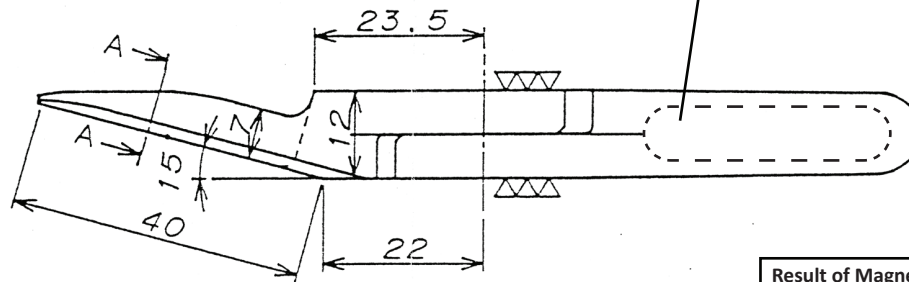

All dimensions are in millimeters (mm) unless otherwise noted

FOR USE IN

GT-N20/SL

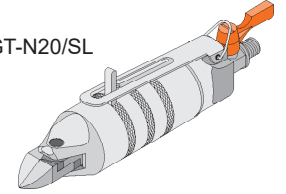

GT-NR20

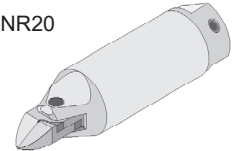

GT-NS20

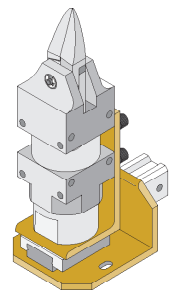
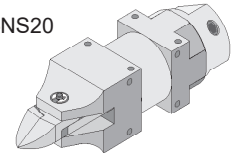

GT-NB20LW-10TM
GT-NB20LW-10SM

Result of Magnetic Force Measurement

If a magnetic sensor is installed nearby, please review the magnetic force levels

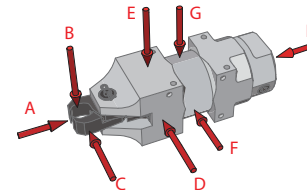

PART NO.	A	B	C	D	E	F	G	H
NM20AB360	85	10	10	5	32	5	2	0

Measurement unit: Gauss / Measuring device: Gaussmeter GM-1200
Manufactured by DENSHUJIKI INDUSTRY Co., Ltd., Japan

EFFECTIVE CUT:	35	APPLICATION:	PLASTIC
BLADE VARIATIONS		MATERIAL:	ALLOY STEEL
ALLOY STEEL:	NM20AB360	EDP#	EXP-14533
CARBIDE:	CALL JDV	AKA:	
HIGH SPEED STEEL:	CALL JDV	Rev.	Rev. Date: 09.28.2021
EQUIVALENT / ALTERNATIVE TO:	MAGNET SPRING SERIES		

MODEL NO.	NM20AB360
VESSEL PROFESSIONAL TOOLS	NIPPER BLADE
DRAWING #:	BLNI 1634

VESSEL's Exclusive North American Distributor

Jdv JDV Products Inc.
22-01 Raphael Street, Fair Lawn, NJ 07410
Tel: 201-796-1720 Fax: 201-796-9399
www.vesseltools.com