

**CAUTION**

Use Appropriate Safety Precautions

**Strong Magnetic Field****FOR USE IN**

GT-N30/SL

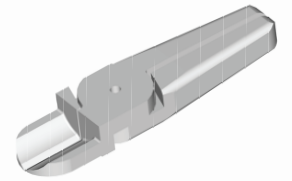
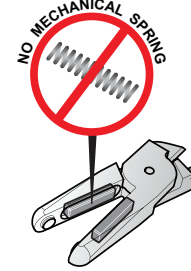
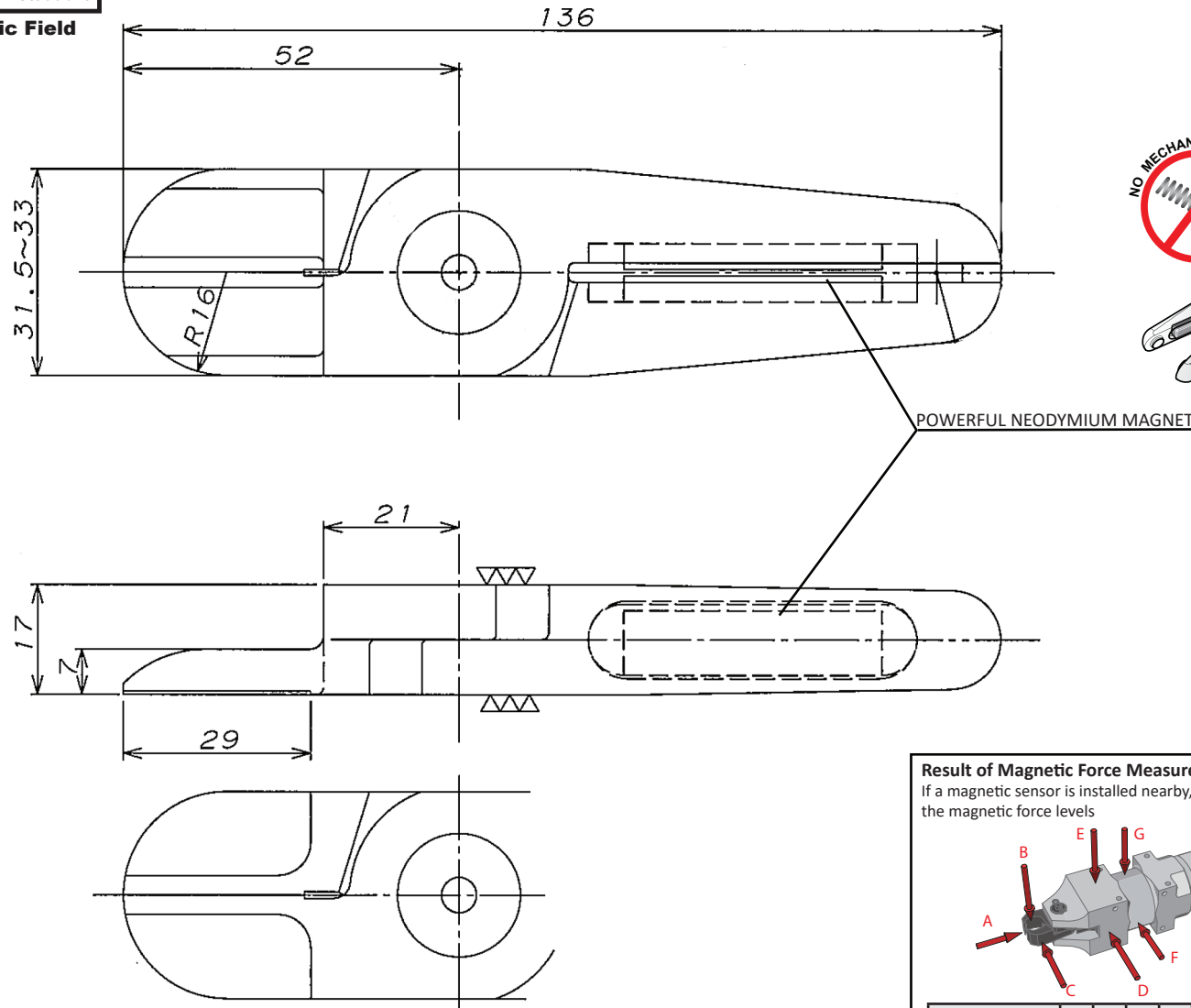
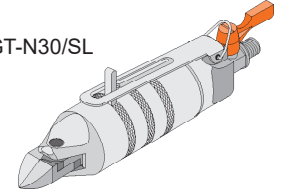

GT-NR30

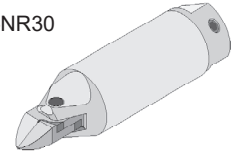

GT-NS30

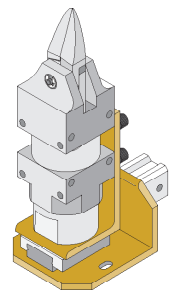
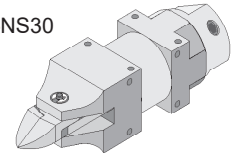
GT-NB30LW-10TM  
GT-NB30LW-10SM**Result of Magnetic Force Measurement**

If a magnetic sensor is installed nearby, please review the magnetic force levels

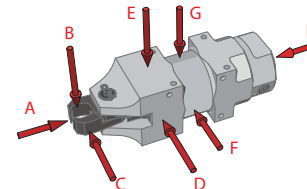

PART NO.	A	B	C	D	E	F	G	H
NM30AJ	34	8	8	6	42	15	30	3

Measurement unit: Gauss / Measuring device: Gaussmeter GM-1200  
Manufactured by DENSHUJIKI INDUSTRY Co., Ltd., Japan

All dimensions are in millimeters (mm) unless otherwise noted

EFFECTIVE CUT:	29	APPLICATION:	PLASTIC
BLADE VARIATIONS		MATERIAL:	ALLOY STEEL
ALLOY STEEL:	NM30AJ	EDP#	360261
CARBIDE:	CALL JDV	AKA:	
HIGH SPEED STEEL:	CALL JDV	Rev.	Rev. Date: 02.26.2021
EQUIVALENT / ALTERNATIVE TO:			

MODEL NO.	NM30AJ
<b>VESSEL</b> PROFESSIONAL TOOLS	<b>NIPPER BLADE</b>
DRAWING #:	BLNI1313

**VESSEL's Exclusive North American Distributor****Jdv** JDV Products Inc.

22-01 Raphael Street, Fair Lawn, NJ 07410

Tel: 201-796-1720 Fax: 201-796-9399

www.vesseltools.com